

SERVICE DEPT.
NOT FOR SALE

HEATHKIT® ASSEMBLY MANUAL

SERVICE DEPT.
NOT FOR SALE

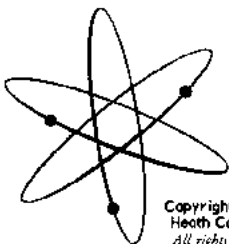
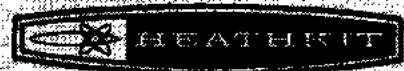

Copyright © 1968
Heath Company
All rights reserved

IMPEDANCE BRIDGE

MODEL IB-28











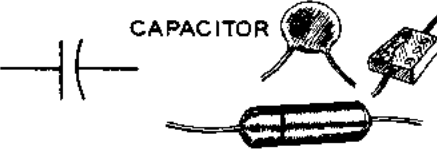
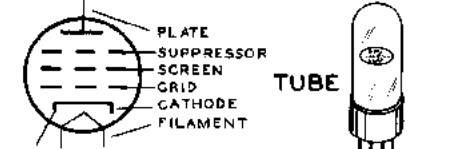
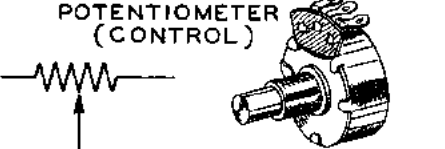
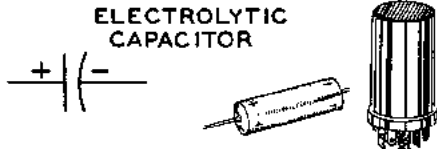



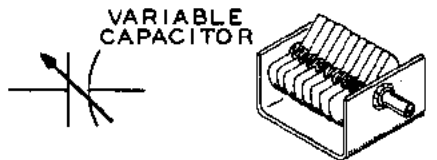
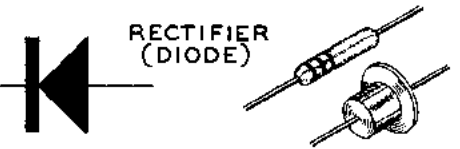
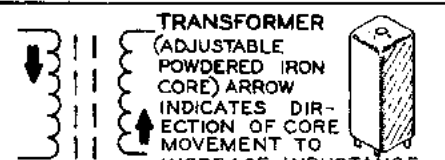
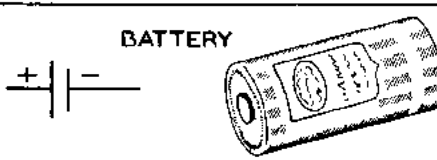
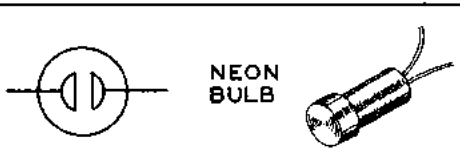
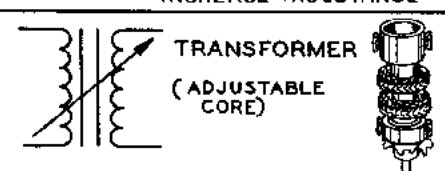
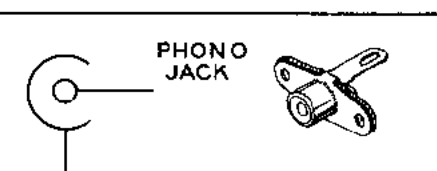
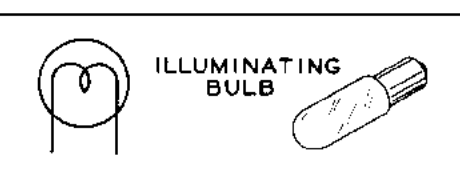
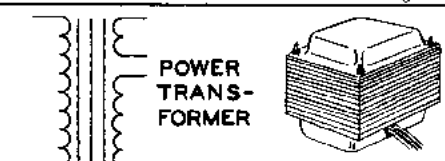

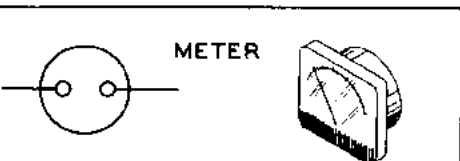
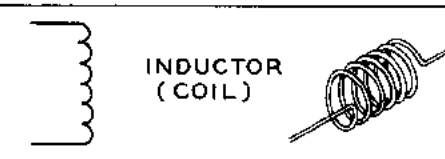

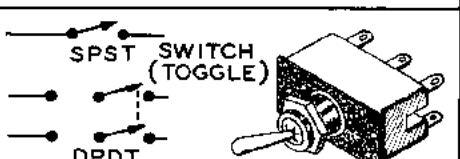
595-995-01

12-20-68

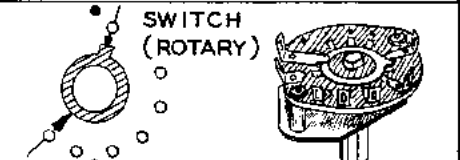
TYPICAL COMPONENT TYPES

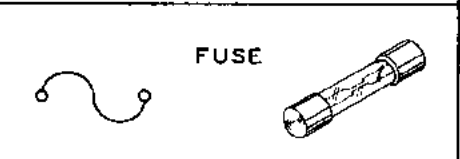
This chart is a guide to commonly used types of electronic components. The symbols and related illustrations

should prove helpful in identifying most parts and reading the schematic diagrams.

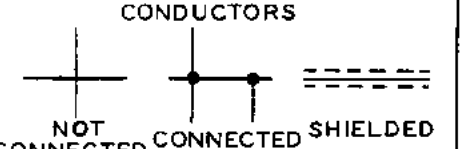
<p style="text-align: center;">RESISTOR</p> 	<p style="text-align: center;">CAPACITOR</p> 	<p style="text-align: center;">TUBE</p> 
<p style="text-align: center;">POTENTIOMETER (CONTROL)</p> 	<p style="text-align: center;">ELECTROLYTIC CAPACITOR</p> 	<p style="text-align: center;">PNP TRANSISTOR</p>  <p style="text-align: center;">NPN TRANSISTOR</p> 
<p style="text-align: center;">TRANSFORMER (IRON CORE)</p> 	<p style="text-align: center;">VARIABLE CAPACITOR</p> 	<p style="text-align: center;">RECTIFIER (DIODE)</p> 
<p style="text-align: center;">TRANSFORMER (ADJUSTABLE POWDERED IRON CORE) ARROW INDICATES DIRECTION OF CORE MOVEMENT TO INCREASE INDUCTANCE</p> 	<p style="text-align: center;">BATTERY</p> 	<p style="text-align: center;">NEON BULB</p> 
<p style="text-align: center;">TRANSFORMER (ADJUSTABLE CORE)</p> 	<p style="text-align: center;">PHONO JACK</p> 	<p style="text-align: center;">ILLUMINATING BULB</p> 
<p style="text-align: center;">POWER TRANSFORMER</p> 	<p style="text-align: center;">PHONE JACK</p> 	<p style="text-align: center;">METER</p> 
<p style="text-align: center;">INDUCTOR (COIL)</p> 	<p style="text-align: center;">RECEPTACLE</p> 	<p style="text-align: center;">SPST SWITCH (TOGGLE)</p>  <p style="text-align: center;">DPDT</p> 
<p style="text-align: center;">PIEZOELECTRIC CRYSTAL</p> 	<p style="text-align: center;">SPEAKER</p> 	<p style="text-align: center;">SWITCH (ROTARY)</p> 
<p style="text-align: center;">BINDING POST</p> 	<p style="text-align: center;">MICROPHONE</p> 	<p style="text-align: center;">FUSE</p> 
<p style="text-align: center;">ANTENNA</p> 	<p style="text-align: center;">EARTH GROUND</p>  <p style="text-align: center;">CHASSIS GROUND</p> 	<p style="text-align: center;">CONDUCTORS</p> 

Assembly
and
Operation
of the



IMPEDANCE BRIDGE
MODEL IB-28

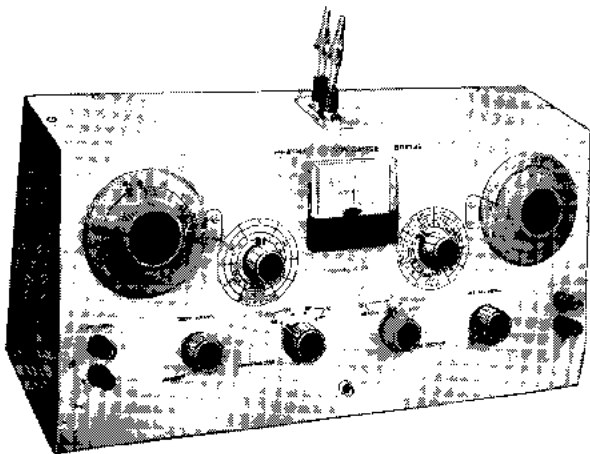

TABLE OF CONTENTS

General Description.	2
Specifications.	3
Measurements.	4
Notes On Assembly And Wiring.	6
Step-By-Step Assembly.	6
Mounting Of Parts On Chassis.	7
Wiring The Chassis.	8
Mounting Of Parts On Panel.	11
Wiring Of CRL Switch.	11
Wiring Of Resistors On Range Switch.	11
Wiring Of The Panel.	12
Wiring Common To Panel And Chassis.	14
Initial Adjustments.	17
Operation.	18
In Case Of Difficulty.	21
Voltage Chart.	21
Bibliography.	21
Parts List.	22
Replacement Parts Price List.	24
Chassis Photograph.	26
Schematics.	27-31

GENERAL DESCRIPTION

The Heathkit Model IB-28 Impedance Bridge is a self-contained, direct reading precision laboratory instrument designed for rapid and accurate measurement of resistance, capacitance, inductance, dissipation factors of condensers, and storage factors of inductors.

The Heathkit Impedance Bridge is a self-powered four-arm bridge of standard design for use in laboratories, service shops and schools. By use of switches, a number of basic bridge circuits are obtained.

Resistance is measured with an internal well filtered power supply operating directly from 105-125 volts AC, or 210-250 volts AC, 50/60 cycles. This supply uses a transformer, silicon diode, and bridge rectifier.

A 100-0-100 microampere meter is used for determining balance. A 2.2 Ω resistor is shunted across the meter for protection. This may be cut out for final balance.

A built-in vacuum tube adjustable phase shift generator supplies 1000 cycles for alternating voltage measurements. A trimmer condenser provides for setting the frequency of the oscillator by means of a laboratory standard if desired. Binding posts are available for connecting to an external generator for measurements at frequencies other than 1 kc. Battery type tubes are used so that a warming up period is not required and also to eliminate change in operating characteristics due to thermal effect.

The built-in vacuum tube detector unit and meter rectifier make possible the use of the meter for AC measurements thus making unnecessary the usual headset or other device for such measurements. Provision is made for using an external detector when desirable.

Refer to the "Kit Builders Guide" for complete information on unpacking, parts identification, tools, wiring, soldering, and step-by-step assembly procedures.

SPECIFICATIONS

Circuit.	4-arm impedance bridge.
DC Measurements.	Built-in power supply operating directly from 120 VAC. Panel binding posts provide for use of external supply.
Meter.	100-0-100 microampere meter.
AC Measurements.	Built-in 1000 cycle vacuum tube oscillator. Terminals on panel provide for connecting an external generator for measurement at other frequencies.
Detector.	Vacuum tube detector and rectifier make use of built-in meter. Panel binding posts provide for connection to external detector.
Resistance.	0.1 Ω to 10 megohm.
Capacitance.	100 $\mu\mu f$ to 100 μfd .
Inductance.	0.1 mh to 100 h.
Dissipation Factor (D)	0.002 to 1.
Storage Factor (Q)	0.1 to 1000.
Accuracy.	1/2 of 1% decade resistors used, 1/2 of 1% silver mica condensers used. Accuracy is limited more by interpretation of scales and workmanship of assembly. The following is normal: Resistance $\pm 3\%$ Capacitance $\pm 3\%$ Inductance $\pm 10\%$ Dissipation Factor ($D = \omega CR$) $\pm 20\%$ Storage Factor ($Q = \omega L/R$) $\pm 20\%$ Accuracy will fall off at extreme outer limits.
Power Requirements.	105-125 VAC or 210-250 VAC, 50/60 cycles, 10 watts.
Tube Complement.	2 - 1U4 and 2 - 1L4.
Power Supply.	Power transformer, silicon diode, and bridge rectifier.
Cabinet Size.	8" high x 17" wide x 6" deep.
Shipping Weight.	15 lbs.

MEASUREMENTS

THEORY

A bridge is an arrangement of impedances used for measuring various electrical properties. When used for direct current measurement of resistance, the bridge generally takes the form of the Wheatstone bridge with four resistance arms. This is the standard method for the accurate measurement of resistance.

For the measurement of circuit constants at audio frequencies, the alternating-current bridge is the most widely used device. Measurements of inductance and capacitance are made conveniently and accurately by this method. The type of AC bridge circuit used is determined by the measurement to be made. These circuits are all adaptations of the fundamental Wheatstone bridge circuit.

A characteristic of a coil or condenser which is of importance and which can be measured conveniently on an AC bridge, is the ratio of resistance to reactance. This ratio is defined as the dissipation factor D, and its reciprocal is called the storage factor Q. The defining equations are as follows:

$$D = \frac{1}{Q} = \frac{R}{X} \qquad Q = \frac{1}{D} = \frac{X}{R}$$

where R and X are the series resistance and reactance of the inductance or capacitance being measured.

Dissipation factor is directly proportional to the energy dissipated per cycle and storage factor is directly proportional to the energy stored per cycle. Dissipation factor is more commonly used for condensers because it varies with the loss, while storage factor is more commonly used for inductors since it indicates the voltage step-up in a tuned circuit.

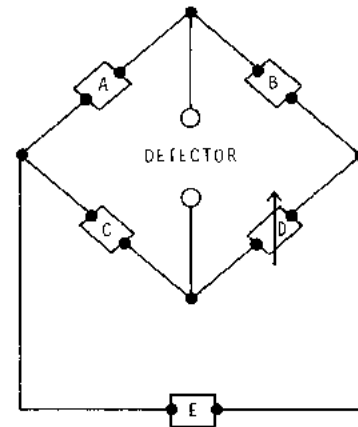

Figure 1

In its basic form the bridge consists of four impedance arms A, B, C, D. The ratio of A and B is adjustable so that the variable arm D serves as a standard for measuring many values at C. The four impedances are connected in series-parallel to a source of potential E between the junctions of A and C. When the voltage drop across arm A is equal to the voltage drop across arm C, no current will flow through the detector and the bridge is in balance. This condition of balance may be indicated by the formula:

$$\frac{A}{C} = \frac{B}{D}$$

Two conditions are necessary for balance. Both the magnitudes of the impedances and the phase angles must be equal.

By the proper use of resistances, condensers, inductors or resistor-condenser combinations in series or parallel, the bridge may be used for measuring resistance, capacity, inductance, dissipation factor (D) and storage factor (Q).

In this bridge, selection of the various bridge combinations is made by setting the function switch to the proper position. The ratio arms of the bridge are controlled by the range switch. Balance is obtained by adjustment of the DQ and CRL dials.

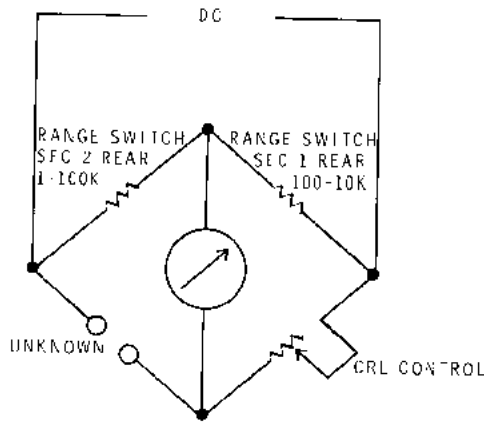

RESISTANCE BRIDGE
(WHEATSTONE)

Figure 2

RESISTANCE

After over a century of use the Wheatstone bridge is still considered to be the fundamental circuit for the measurement of DC resistance. A Wheatstone bridge of four resistance arms, the fourth being the unknown, is used for resistance measurements. The basic equation of balance for the Wheatstone bridge is:

$$R_x = \frac{R_D R_A}{R_B}$$

R_D is read on the CRL control and the ratio R_A/R_B is read on the range dial. Thus the value of the unknown resistance is the product of the readings of the two dials.

CAPACITY

A Capacitance-Comparison bridge is used for the measurement of capacity. This circuit utilizes a

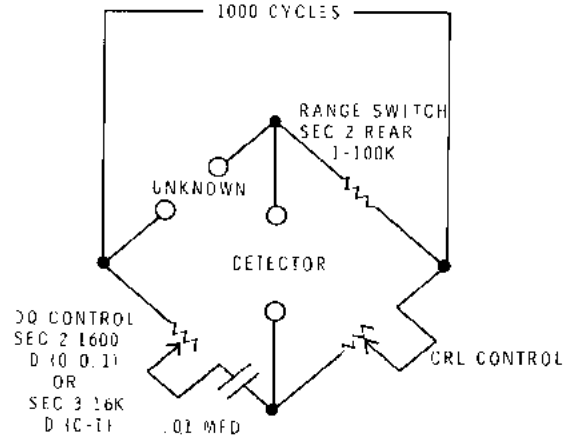

CAPACITANCE BRIDGE
(COMPARISON)

Figure 3

standard condenser in series with a variable resistance. Dissipation factor is also measured with this circuit.

INDUCTANCE

The Maxwell bridge is used for measuring inductances when the storage factor is below 10. In this bridge, inductance is measured in terms of capacitance. A condenser has some advantages as a standard as it gives practically no external field and is more compact.

For measuring inductances with storage factors between 10 and 1000, the Hay bridge is used. This is a modification of the Maxwell bridge. In the Hay bridge, the condenser is in series with the resistance, while in the Maxwell bridge, the condenser is in parallel with the resistance.

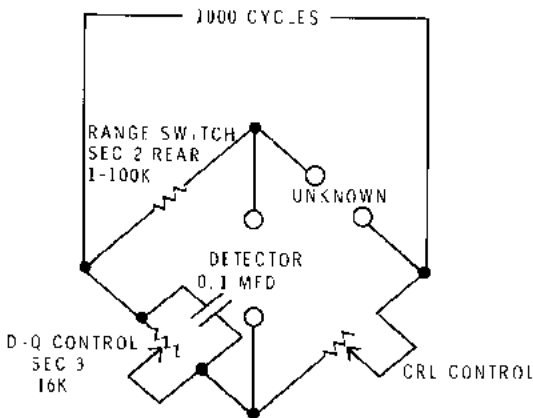

MAXWELL INDUCTANCE BRIDGE
(Q OF 0-10)

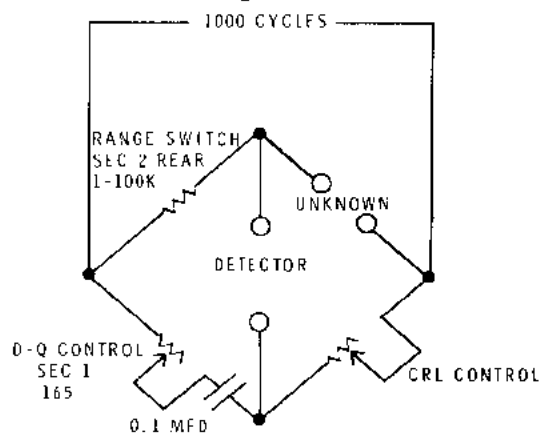

HAY INDUCTANCE BRIDGE
(Q OF 10-1000)

Figure 4

NOTES ON ASSEMBLY AND WIRING

The quality of parts and design of the Heathkit Model IB-28 Impedance Bridge place it in the laboratory equipment class. When constructed in accordance with the instructions in this manual it will give many years of satisfactory service. We therefore urge you to take the necessary time to assemble and wire the kit carefully.

This manual is supplied to assist you in every way to complete the instrument with the least possible chance for error. We suggest you take a few minutes now and read the entire manual through before any work is started. This will enable you to proceed with the work much faster when construction is started. We suggest you retain the manual in your files for future reference, both in the use of the instrument and for its maintenance.

UNPACK THE KIT CAREFULLY AND CHECK EACH PART AGAINST THE PARTS LIST. In so doing, you will become acquainted with each part. Refer to the charts and other information shown on the inside covers of the manual to help you identify any parts about which there may be a question. If some shortage is found in checking the parts, please notify us promptly.

STEP-BY-STEP ASSEMBLY

The construction of the Heathkit Impedance Bridge is broken down into four parts: chassis parts mounting and wiring, panel parts mounting and wiring, wiring common to both chassis and panel, and test and calibration. If the step-by-step procedure is followed with the aid of the figures and the pictorials, little difficulty should be encountered in construction. Be sure to read each step all the way through before you start to do it. When the step is completed, check it off in the space provided.

We suggest that you do the following before any work is started:

1. Go through the entire assembly and wiring instructions. This is an excellent time to read the entire instructions through and familiarize yourself with the procedure.

ROSIN CORE SOLDER HAS BEEN SUPPLIED WITH THIS KIT. THIS TYPE OF SOLDER MUST BE USED FOR ALL SOLDERING IN THIS KIT. ALL GUARANTEES ARE VOIDED AND WE WILL NOT REPAIR OR SERVICE EQUIPMENT IN WHICH ACID CORE SOLDER OR PASTE FLUXES HAVE BEEN USED. IF ADDITIONAL SOLDER IS NEEDED, BE SURE TO PURCHASE ROSIN CORE (60:40 or 50:50 TIN-LEAD CONTENT) RADIO TYPE SOLDER.

Resistors and controls generally have a tolerance rating of $\pm 20\%$ unless otherwise stated in the parts list. Therefore, a 100 K Ω resistor may test anywhere from 80 K Ω to 120 K Ω . (The letter K is commonly used to designate a multiplier of 1000.) Tolerances on condensers are generally even greater. Limits of +100% and -20% are common for electrolytic condensers. The parts furnished with your Heathkit have been specified so as to not adversely affect the operation of the finished instrument.

We strongly urge that you follow the wiring and parts layout shown in this manual. The position of wires and parts is quite critical in this instrument and changes may seriously affect the characteristics of the circuit.

2. Lay out all parts so that they are readily available.

MOUNTING OF PARTS ON CHASSIS

Refer to Figure 5 for the following steps.

NOTE: A plastic nut starter has been provided with this kit. Use it to hold and start nuts on screws. See Page 3 of the Kit Builders Guide for more information.

- () Using 3-48 x 5/16" screws and nuts (no lock-washers) mount the four 7-pin sockets in positions F, H, N and S. Locate the blank spaces as shown in Figure 5 (fold-out from Page 7) so as to have the sockets in the best position for wiring. See Figure 6.

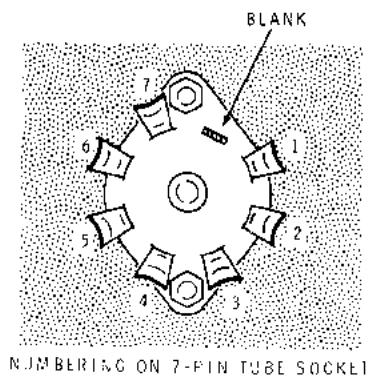

Figure 6

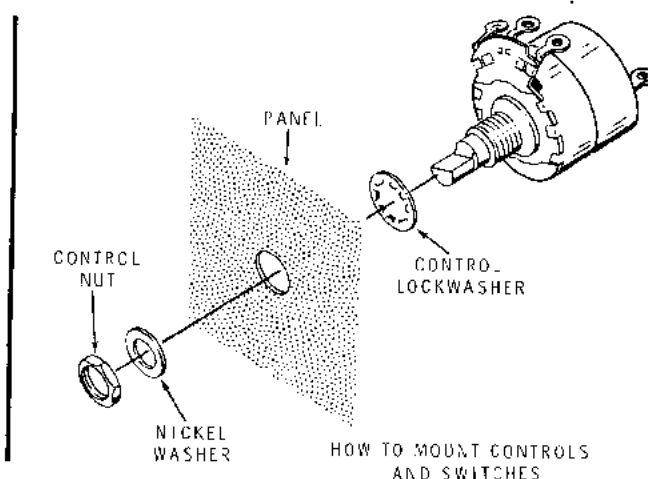

Figure 7

- () Using 6-32 x 3/8" screws, lockwashers and nuts, mount the condenser mounting wafer in position T. Under one of the nuts, in position U, mount a 1-lug terminal strip as shown. Under the other nut, mount a solder lug, positioning as shown.
- () Mount the meter rectifier in position V, using a lockwasher and nut.
- () In positions Q and R, mount a 1-lug and 4-lug terminal strip using a 6-32 x 3/8" screw, lockwasher and nut.
- () In the same manner, mount a 2-lug terminal strip in position J.
- () In position D, mount a 2-lug terminal strip as shown.
- () In position C, mount a 2-lug terminal strip (vertical) as shown.
- () Mount the trimmer condenser in position G, using 6-32 x 3/8" screw, lockwasher and nut.
- () Mount the power transformer in position B. Position the leads as shown in Figure 5. Under the nut in position A, mount a 4-lug terminal strip using 6-32 x 3/8" screws.
- () In position E, mount the 10 KΩ control (generator level control) with the switch on the rear. Use lockwasher and nut as shown in the diagram. Do not tighten this nut as it will be used later for attaching the chassis to the panel. See Figure 7.
- () In the same manner, in position P, mount the other 10 KΩ control (zero adjust control). Again do not tighten.
- () Mount the 1000-1000 μfd condenser on the mounting wafer in position T. The manner of mounting is shown in Figure 8. Secure the condenser to the wafer by twisting each of the four mounting lugs about 1/8 turn with the pliers. Hold the condenser firmly against the wafer while twisting the lugs.
- () Solder the indicated condenser mounting lug to the mounting wafer. This insures good electrical contact.

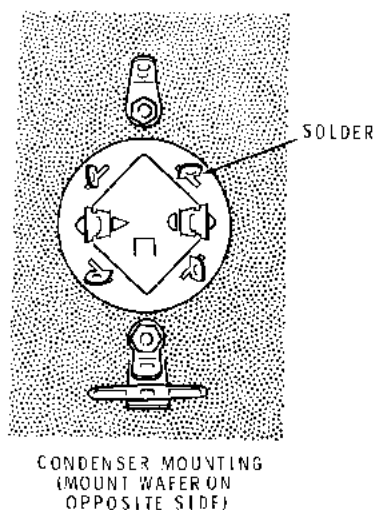

Figure 8

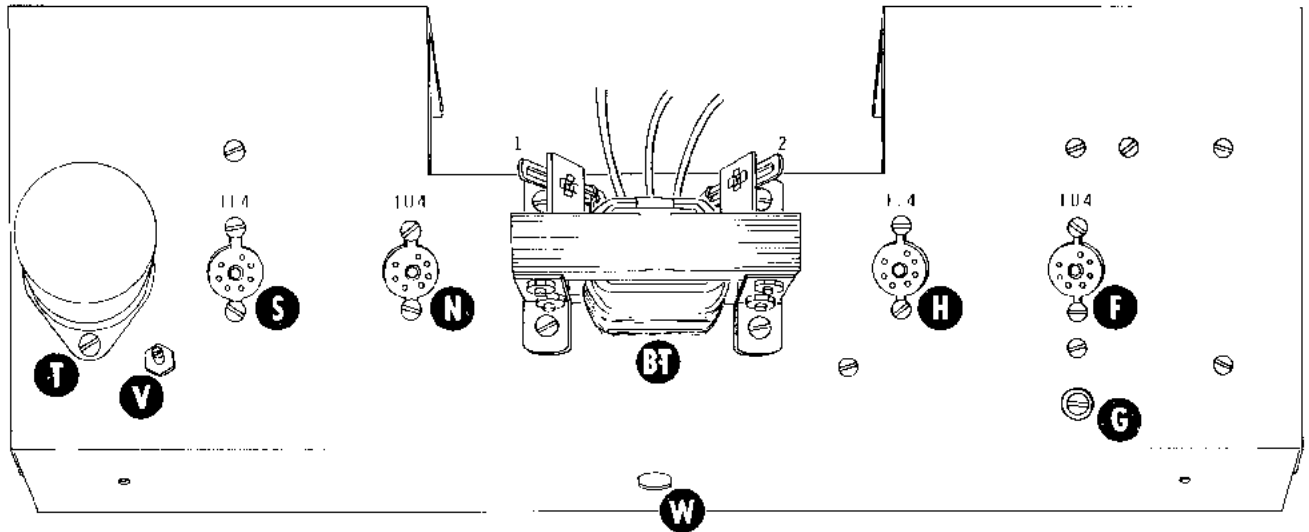

Figure 9

- () Mount the bridge transformer on the top of the chassis in position BT, as shown in Figures 5 and 9. Use the #8 nickel washers under the heads of the screws. Under the nut in position L, mount a 1-lug terminal strip and a ground lug. Under the nut in position M, mount a 4-lug terminal strip and a ground lug. Use 6-32 x 3/8" screws. In position K, use a 6-32 x 1" screw and mount the bridge rectifier under the nut using a lockwasher.

WIRING THE CHASSIS

Read the Kit Builders Guide for wiring and soldering information.

The leads on components such as transformers, resistors and condensers are frequently longer than necessary. When wiring these parts into the circuit, the leads should be cut to the proper length. Not only will this result in a neater looking instrument, but in many instances proper operation is impossible with long untrimmed lead wires in critical parts of the circuit.

Unless otherwise indicated, insulated wire is used in all steps. Remove 1/4" of insulation from the end before attempting to connect or solder a wire. Wherever there is a possibility of the bare leads on resistors and condensers shorting to other parts or to chassis, the leads should be covered with insulated sleeving. This is indicated in the instructions by the phrase, "use sleeving."

(S) means solder.

(NS) means do not solder yet.

Refer to Pictorial 1 for the following steps.

Refer to Figure 5 for the location of connection numbers.

NOTE: Perform only one of the next two steps. Use the step for the line voltage in your area.

- () If your line voltage is 105-125 VAC, connect the black-red and the black-yellow transformer leads to A1 (NS). Connect the black-green and the black leads to A3 (NS).
- () If your line voltage is 210-250 VAC, connect the black-red transformer lead to A1 (NS). Connect the black-green and the black-yellow leads to A2 (S-2), and connect the black lead to A3 (NS).
- () Twist together the two orange leads of the power transformer. Connect one of them to J1 (NS) and the other one to J2 (NS).
- () Connect the short red lead from the power transformer to C2 (NS).
- () Connect the long red lead of the power transformer to L1 (NS).
- () Connect a short wire from J1 (S) to K1 (yellow) on the bridge rectifier (S). It may be convenient to remove the rectifier for easier wiring to the lugs.

- () Connect another short wire from J2 (S) to the other yellow lug K2 of the bridge rectifier (S).
- () Connect a wire from H7 (S) to T2 of the filter condenser (NS).
- () Run a short piece of bare wire between H1 (S) and H5 (NS).
- () Connect a wire from H5 (S) to F7 (S).
- () Connect a wire from H3 (NS) to D1 (NS).
- () Strip the insulation from 1" of the end of a piece of wire. Run the wire through F1 (NS) to F5 (NS). Connect the other end of the wire to the ground lug in position L (NS).
- () Connect a wire from E1 (S) on the generator level control to F1 (NS).
- () Connect one lead of a .02 μ f condenser to F1 (NS). Connect the other lead of this condenser to F3 (NS) use sleeving. Any "outside foil" or "ground" markings on paper capacitors can be disregarded in wiring this circuit. They may be connected with either "polarity."
- () Connect a 4.7 megohm resistor between F1 (S) and F6 (NS).
- () Connect a wire from H3 (NS) to M3 (NS).
- () Connect a wire from the red lug of the bridge rectifier, K3 (NS) to M1 (NS).
- () Using a short piece of bare wire, connect the two black lugs, K4 and K5 of the bridge rectifier together (NS). (This may already be done in the rectifier in your kit.)
- () Connect a wire from K5 (S) to L2 (NS).
- () Connect the positive lead (marked +) of the 100 μ f condenser to the red lug of the bridge rectifier K3 (S) use sleeving.
- () Connect the other lead of this condenser to L2 (NS).
- () The 20-20 μ f 150 volt condenser has two leads on the end marked positive (+). Connect one of these leads to D1 (NS). Connect the other lead from the same end to C1 (NS) and use sleeving on this lead.
- () Connect the lead on the other end of this condenser to L1 (NS).
- () Connect a 2.2 K Ω resistor (red-red-red) from C1 (NS) to D1 (S).
- () Connect the cathode lead of a silicon diode to C1 (S) and the other lead to C2 (NS). The cathode end is marked with a color end, a color dot, or a color band.
- () Connect one lead of a .02 μ f condenser to E3 (S). (Use sleeving.) Connect the other lead to D2 (NS).
- () Connect a wire from E2 (S) to H6 (NS).
- () Referring to Detail 1A, prepare a 2.2 megohm (red-red-green) 1/2 watt resistor and 310 μ f condenser combination.
- () Connect this combination between H6 (S) and H2 (NS).
- () Connect one lead of a 470 K Ω resistor (yellow-violet-yellow) to D2 (S) use sleeving. Connect the other lead to F2 (NS).
- () Connect the 220 K Ω resistor (red-red-yellow) from F2 (NS) to H3 (NS).
- () Connect the 680 K Ω resistor (blue-gray-yellow) from F3 (S) to H3 (S).
- () Connect one of the 100 μ f (.0001 μ f) condensers from F2 (S) to G2 (NS).
- () Connect one of the 470 K Ω resistors (yellow-violet-yellow) between F5 (NS) and G2 (S).
- () Connect another of the 470 K Ω resistors between F5 (NS) and G1 (NS).
- () Connect a 470 K Ω resistor between F5 (S) and A4 (NS).

- () Connect a .005 μ fd condenser from F6 (S) to A4 (NS).
- () Connect a 100 μ fd (.0001 μ fd) condenser between G1 (S) and A4 (S).
- () Connect a wire from L2 (NS) to R3 (NS).
- () Connect the red lead of the meter rectifier V to R3 (NS).
- () Connect the yellow lead of the meter rectifier V to lug R4 (NS).
- () Connect a short piece of bare wire between S1 (S) and S5 (NS).
- () Connect a piece of wire from S5 (S) to N7 (S).
- () Connect a wire from S3 (NS) to R2 (NS).
- () Connect a wire from R2 (NS) to M3 (NS).
- () Connect a short piece of bare wire between N1 (NS) and N5 (NS).
- () Connect a piece of wire from N5 (S) to the ground lug at M (NS).
- () Connect a wire from S7 (S) to T1 (NS).
- () Connect a 220 Ω 2 watt resistor (red-red-brown) between T1 (NS) and U1 (S).
- () Connect a 220 Ω 2 watt resistor between T2 (NS) and U2 (NS).
- () Connect a 68 Ω resistor (blue-gray-black) between T1 (S) and the solder lug at T (NS).
- () Connect another 68 Ω resistor between T2 (S) and the solder lug (NS).
- () Connect a 22 K Ω resistor (red-red-orange) between R4 (NS) and Q1 (NS).
- () Connect a wire from P3 (S) to R3 (S).
- () Connect one lead of a 47 K Ω resistor (yellow-violet-orange) between P2 (S) (use sleeving) and Q1 (NS).
- () Connect one lead of a 100 K Ω resistor (brown-black-yellow) from P1 (S) (use sleeving) to R2 (NS).
- () Connect a .02 μ fd condenser between R4 (NS) and S2 (NS).
- () Connect a 10 K Ω resistor (brown-black-orange) between R2 (S) and S2 (S).
- () Connect a 1 megohm resistor (brown-black-green) between R4 (S) and R1 (NS).
- () Connect a 1 megohm (brown-black-green) resistor between N6 (NS) and N1 (NS).
- () Connect a third 1 megohm resistor between R1 (NS) and S6 (NS).
- () Connect one lead of a .02 μ fd condenser to N1 (NS) and the other lead of this condenser to R1 (S).
- () Connect a .02 μ fd condenser between N1 (S) and N3 (NS) (use sleeving).
- () Connect a 1000 μ fd (.001 μ fd) condenser between S6 (S) and N2 (NS).
- () Connect a 470 K Ω resistor (yellow-violet-yellow) between N2 (S) and S3 (NS).
- () Connect a 1 megohm resistor (brown-black-green) between N3 (S) and S3 (S).
- () Connect a 1000 Ω resistor (brown-black-red) between M1 (NS) and M2 (NS).
- () Connect a 4700 Ω 1 watt resistor (yellow-violet-red) between M3 (NS) and M4 (NS).

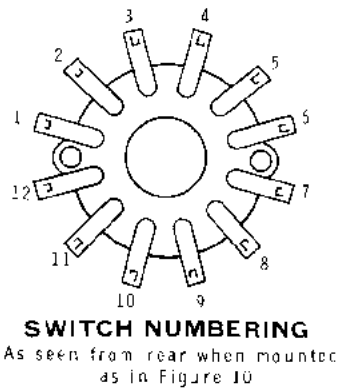

Figure 11

MOUNTING OF PARTS ON PANEL

Before mounting the parts on the panel, the switch on the CRL control, #19-36 should have the resistors mounted. The resistors should also be mounted on the range switch, #63-514. It is important that the switch be in the proper position before soldering the resistors in place. Refer to Figure 10 (fold-out from Page 11) for switch positioning and to Figure 11 for the system used for numbering of contacts.

WIRING OF CRL SWITCH

- () There are nine 1 K Ω precision resistors. Connect one lead of a 1 K Ω resistor to lug 8 of the switch on the CRL control, #19-36 (S).
- () Connect the other lead to lug 9 of the switch (NS).
- () Connect a 1 K Ω resistor between lug 9 (S) and lug 10 (NS).
- () Connect a 1 K Ω resistor between lug 10 (S) and lug 11 (NS).
- () Connect a 1 K Ω resistor between lug 11 (S) and lug 12 (NS).
- () Connect a 1 K Ω resistor between lug 12 (S) and lug 1 (NS).
- () Connect a 1 K Ω resistor between lug 1 (S) and lug 2 (NS).
- () Connect a 1 K Ω resistor between lug 2 (S) and lug 3 (NS).
- () Connect a 1 K Ω resistor between lug 3 (S) and lug 4 (NS).

- () Connect a 1 K Ω resistor between lug 4 (S) and lug 5 (NS).
- () Connect a wire between lug 5 of the switch (S) and the center lug of the 1200 Ω control on the rear of the switch (S). See Figure 10.

This completes the preliminary wiring of the CRL switch.

WIRING OF RESISTORS ON RANGE SWITCH

- () Connect one lead of a 9 K Ω precision resistor to R1R3 (S). (Be sure the switch is in the proper position.) R1R3 means range switch, first deck (counting from panel out), rear of deck, contact #3.
- () Connect the other lead to R1R12 (NS). (Use sleeving.)
- () Connect a 900 Ω precision resistor between R1R12 (S) and R1R11 (NS).
- () Connect one lead of a 100 Ω precision resistor to R1R11 (S).
- () Connect the other lead to R1R10 (NS).
- () Connect a 1 Ω precision resistor between R2R8 (NS) (use sleeving) and R2R6 (NS).
- () Connect a 9 Ω precision resistor between R2R6 (S) and R2R5 (NS).
- () Connect a 90 Ω precision resistor between R2R5 (S) and R2R4 (NS).
- () Connect a 900 Ω precision resistor between R2R4 (S) and R2R3 (NS).
- () Connect a 9 K Ω precision resistor between R2R3 (S) and R2R2 (NS).
- () Connect a 90 K Ω precision resistor between R2R2 (S) and R2R11 (S).

This completes the preliminary wiring of the range switch.

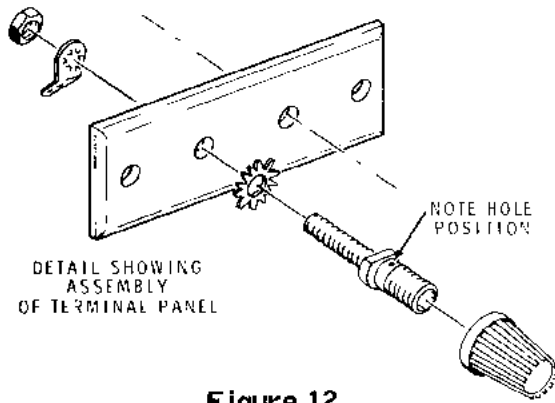

Figure 12

Refer to Pictorial 2 for the following steps.

- () Mount the binding posts on the terminal board insulator as shown in Figure 12. Position the binding post red and black caps and the solder lugs as shown in the Pictorial.
- () Using 6-32 screws, lockwashers and nuts, mount the terminal board insulator on the top of the panel in position TS.
- () Referring to Figure 13, mount the binding posts in positions BP-1, 2, 3, and 4 as shown in Figure 10.
- () Using 6-32 x 3/4" screws and 1/2" spacers, mount the CRL mounting bracket on the panel in position CC.
- () Mount the CRL control on the CRL mounting bracket. Do not use a control nickel washer.
- () Mount the range switch, #63-514, in position DB as shown in Figure 7 on Page 7.

Similarly mount the following components.

- () Mount the function switch, #63-515, in position FS.
- () Mount the DQ control in position DC. This is the 3-gang control.
- () Mount the generator switch, #63-513, in position GS.
- () Mount the detector switch, #63-512, in position DS.

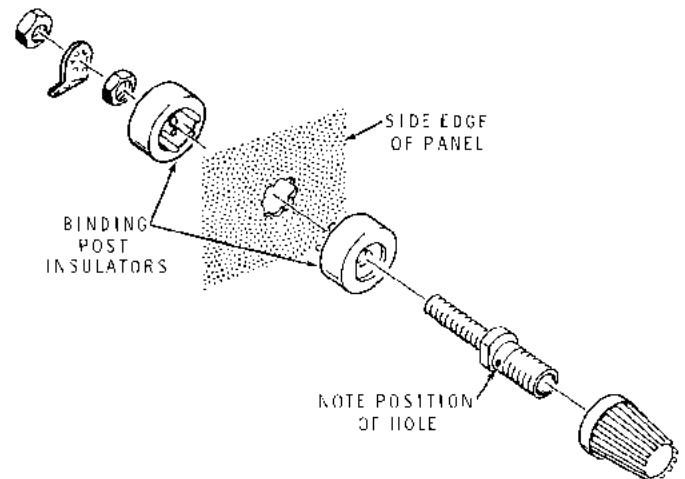

Figure 13

- () Mount the 100-0-100 microampere meter in position MM using the washers and nuts provided with the meter. Use the #8 solder lugs on the meter terminals. Remove and discard any wires between the meter terminals.

WIRING OF THE PANEL

The accuracy of the bridge is dependent on the wiring. Heavy bus wire is provided for wiring the switches. The resistance of the wiring is held to a minimum by the large bus wire. The capacity of the wiring is held to a minimum by using an open, rigid style of wiring as shown in the pictorial. Notice carefully the proper positions of the switches on the panel. Also the proper numbering of the contacts on the switches. The switches are shown in the schematic in the same positions as they appear on the panel. Check with this as well as with the pictorial. Make a good mechanical and electrical joint of each connection. Poor connections will impair the accuracy of the bridge.

Before wiring the panel, place one end of the bus wire in a vise and pull the other end with a pair of pliers. Pull until the wire stretches. This will remove any kinks and will stiffen the wire, resulting in a better and neater job of wiring.

Proceed carefully, as once the switches are wired, it is very difficult to change the connections to correct an error.

- () Run a piece of bus (heavy solid wire) from CC6 (S) through F1R6 (NS) to F2R6 (NS). Now solder F1R6.
- () Connect F1F5 (S) to R1R1 (S) and R2R1 (NS). Use bus.
- () Connect F1F3 (S) to TS2 (S). Use bus.
- () Connect F1R2 (S) to TS1 (S). Use bus.
- () Run one end of a piece of bus wire through F2F4 (NS) to F2R4 (S). Now solder F2F4.
- () Connect the other end to R2R8 (S).
- () Run a piece of bus wire through F3R12, F3F12, F2F12, F1R12 to F1F12. Now solder all but F3R12.
- () Run a bus wire from F2R1 (S) to R1R10 (S).
- () Using insulated hookup wire, connect R1F7 (S) to G1R4 (S).
- () Again using insulated wire, connect R2F9 (S) to G2R12 (S).
- () Run a bus wire from R2R1 (S) to D7 (S).
- () Using insulated wire, connect MM2 (S) (negative terminal of the meter) to D11 (S).
- () Connect a bus wire from F2R6 (S) to G2R4 (S).
- () Run a bus wire from CRL3 (S) through MM1 (NS) to F1R9 (NS). Now solder MM1.
- () Connect one lead of a .1 μ fd precision condenser to F1R9 (S). (Use sleeving.)
- () Connect the other lead to F3R5 (NS). (Use sleeving.)
- () Run a bus wire from F3R5 (S) to lug 2 of DQ1 (S).
- () Run a bus wire from F3R3 (S) to lug 3 of DQ1 (S).
- () Run a bus wire from F3F6 (NS) through lug 2 of DQ3 (NS) to lug 2 of DQ2 (S). Now solder DQ3.
- () Run a bus wire from F3F9 (S) through F3R9 (S) to lug 1 of DQ3 (S).
- () Run a bus wire from F3R11 (S) to lug 1 on DQ2 (S).
- () Run a bus wire from F3R12 (S) to G2R10 (S).
- () Connect one lead of a .01 μ fd (10,000 $\mu\mu$ f) precision condenser to F3F6 (S). (Use sleeving.)
- () Connect the other lead to F3F4 (NS). (Use sleeving.)
- () Run a bus wire from F3F4 (S) to MM1 (S). The connection to MM1 is best made by wrapping the wire from F3F4 around the wire from MM1 near the solder lug.
- () The panel is now mounted on the chassis by removing the nuts on the two controls mounted on the chassis. The panel is put in place and the nickel washers and nuts put on the controls. It may be necessary to omit the lockwashers on these two controls because of the extra thickness of the panel and chassis.

WIRING COMMON TO PANEL AND CHASSIS

NOTE: Use insulated hook-up wire unless otherwise specified. Numbers refer to Pictorial 3.

- 9 () Connect the yellow lead of the bridge coupling transformer to R1F4 (S).
- 4 () Connect the red lead of the transformer to R1F9 (S).
- 8 () Connect a wire from R2F7 (S) to M4 (S).
- 7 () Connect a wire from R2F12 (S) to M2 (S).
- 2 () Connect a wire from D9 (S) to BP1 (S).
- 1 () Connect a wire from BP2 (S) to the solder lug at T (S).
- 20 () Connect a short piece of bus wire from the ground lug at M (NS) to the bus wire on the positive terminal of the meter M1 (S). The last connection is made by looping the end of the short wire securely around the wire from the meter so as to make a good mechanical connection.
- 23 () Connect a .02 μ fd condenser from G2R5 (NS) to ground lug at L (NS).
- 5 () Connect a 2.2 Ω resistor (red-red-gold) between D10 (S) and the ground lug at M (S).
- 6 () Connect a 1000 μ mf (.001 μ fd) condenser from N6 (S) (use sleeving) to D8 (S).
- 3 () Connect a wire from Q1 (S) to D12 (S).
- 11 () Connect the blue lead of the bridge transformer to G1R10 (S).
- 19 () Strip 1" of insulation from one end of a piece of wire. Pass this through G1R5 (NS) to G2R5 (S). Now solder G1R5.
- 19 () Connect the other end of the wire to BP4 (S).
- 18 () Again strip 1" of the insulation from a piece of wire. Pass it through G2R6 (NS) to G1F6 (S). Now solder G2R6.
- 18 () Connect the other end to L1 (S).
- 14 () Connect a wire from G1R3 (S) to M3 (S).
- 21 () Run a piece of bus wire from G2R2 (S) to BT1 (S).
- 13 () Run a wire from G1F1 (S) to U2 (S).
- 12 () Run a wire from G1F12 (S) to M1 (S).
- 15 () Strip 1" of insulation from one end of a piece of wire. Pass this through G1R11 (NS) to G2R11 (S). Now solder G1R11.
- 15 () Connect the other end to BP3 (S).
- 22 () Run a piece of bus wire from G2R8 (S) to BT2 (S).
- 17 () Connect a wire from G1F7 (S) to the ground lug at L (S).
- 16 () Connect a wire from G1R9 (S) to H2 (S).

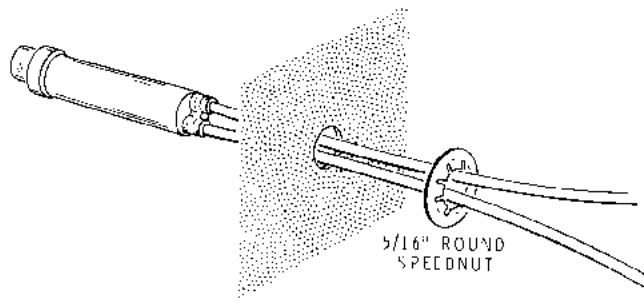

Figure 14

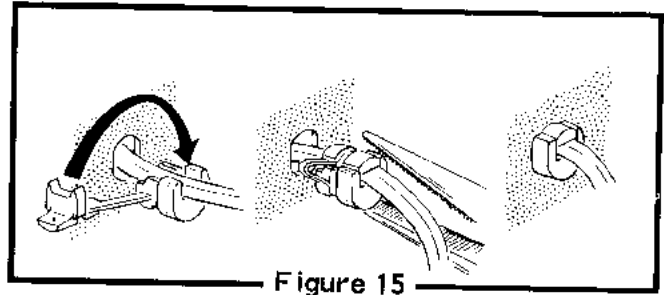

Figure 15

- () Using a round speednut, mount the pilot lamp in position DL. Refer to Figure 14.
- ②④ () Connect one lead of the pilot lamp to L2 (S).
- ⑩ () Connect the other lead of the pilot lamp to C2 (S).

NOTE: Observe that the two edges of the flat line cord are different. One edge is smooth but the other edge is ribbed for identification.

- () Separate the 3 wires of the line cord for a distance of 8" from the free end. Then cut off the green lead and the ribbed lead 6-1/2" from the free end of the line cord. Remove 1/4" of insulation from the ends of the three wires and melt a small amount of solder on the end of each to keep the fine strands together.
- () At a point 14-1/2" from the end of the line cord, position the strain relief as shown in Figure 15, which shows the strain relief (#75-71) for the flat line cord supplied with the kit. If you are using a round line cord, use the other (#75-30) strain relief.
- () Insert the free end of the line cord through hole W from the rear of the chassis; then install the strain relief in hole W as shown.
- () Connect the smooth line cord lead to E4 (S).
- () Solder the green line cord wire to the eyelet in the mounting foot of terminal strip A (S).
- () Connect the ribbed line cord lead to A3 (S).
- () Connect an insulated wire to E5 (S). Wrap this wire around the smooth line cord lead and connect it to A1 (S).
- () Install the DQ knob. Use 8-32 set screws. A reasonable degree of accuracy may be obtained by simply setting the knob at zero at the extreme end of rotation of the control. If maximum accuracy is desired, do not tighten the DQ knob setscrew securely at this time. Calibration instructions will appear later.
- () Install the CRL control ring and knob. Use 8-32 setscrews.
- () Using #6 self tapping screws, mount the two stationary pointers for the DQ and CRL controls.
- () Adjust the ring of the CRL control so the numbers line up with the stationary pointer. The knob will be adjusted later.

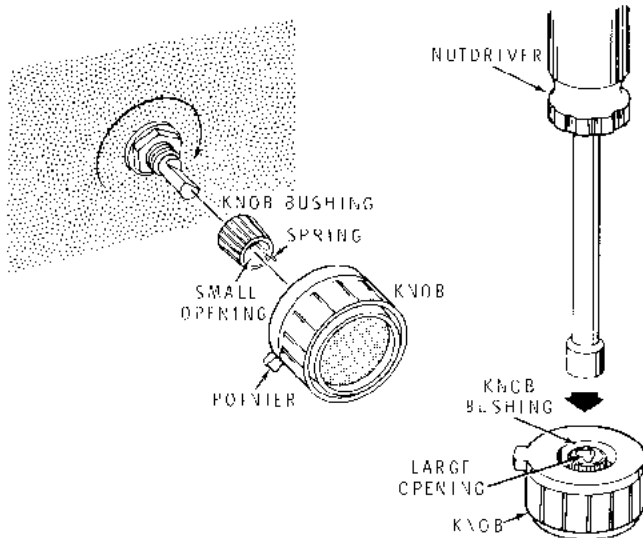

Figure 16

Refer to Figure 16 for the following steps.

The remaining knobs supplied with this kit use knob bushings that provide permanent positive action without the use of setscrews. In the following steps, you will install knobs on the six remaining panel shafts. Perform these steps carefully, since it is difficult to remove a bushing from a knob once it is fully inserted.

- () Place a knob bushing on each of the six shafts; the spring tab on the bushing should face outward.
- () Turn each control shaft except the Detector switch shaft to its full counterclockwise position. The Detector switch shaft should be positioned at the most clockwise position.
- () Press knobs firmly onto the control bushings with the white index marks of the knobs positioned to agree with the knob index marks shown in Figure 19.
- () Remove the knobs with the bushings still inserted in them; then drive the bushings into the knobs. Use a nutdriver, or other appropriate size tool, as shown.
- () Reinstall each knob on the proper control shaft.

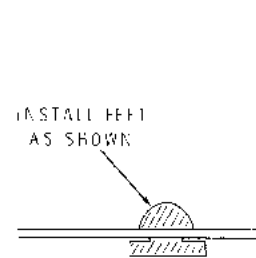

Figure 17

- () Install the rubber feet in the bottom of the cabinet as shown in Figure 17.
- () Install the 1L4 and 1U4 tubes in their proper sockets. See Figure 9 on Page 8.

IMPORTANT WARNING

MINIATURE TUBES CAN BE EASILY DAMAGED WHEN PLUGGING THEM INTO THEIR SOCKETS. THEREFORE, USE EXTREME CARE WHEN INSTALLING THEM. WE DO NOT GUARANTEE OR REPLACE MINIATURE TUBES BROKEN DURING INSTALLATION.

- () Two alligator clips with banana plugs are provided as test leads. These plug into the terminals of the bridge as shown in Figure 18. The unknown may then be clipped between them.

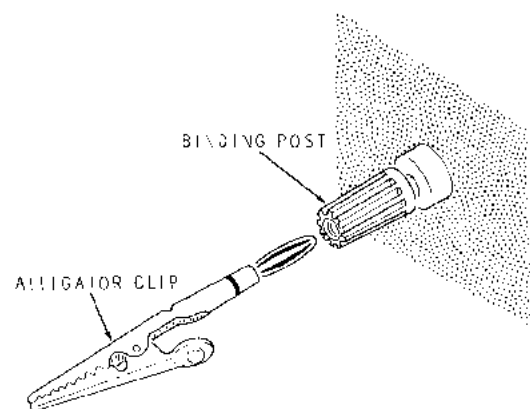

Figure 18

- () After making the initial adjustments, install the instrument in the cabinet and fasten with two #6 self tapping screws through the rear into the chassis, and with seven #6 screws through the panel into the cabinet.

NOTE: The blue and white identification label shows the Model Number and Production Series Number of your kit. Refer to these numbers in

any communications with the Heath Company; this assures you that you will receive the most complete and up-to-date information in return.

- () Carefully peel away the paper backing from the blue and white identification label. Then press the label firmly into place on the rear of the cabinet.

INITIAL ADJUSTMENTS

Plug the line cord into 50/60 cycles AC outlet of the proper voltage, **SERIOUS DAMAGE TO THE TRANSFORMER WILL RESULT IF PLUGGED INTO A DC SUPPLY.** Turn on the power switch on the GENERATOR LEVEL control.

CAUTION: The circuit ground and the case of this instrument are both connected to the power line ground through the green wire of the line cord. Always connect the ground test lead of this device to the chassis, or ground, of the circuit being tested or measured.

The oscillator circuit is designed to operate somewhere between 800 and 1200 cps. The actual frequency will depend on the components. A trimmer condenser is provided so that the frequency may be set at approximately 1 kc by use of an audio generator. The most convenient method is to use an oscilloscope. Set the audio generator at 1 kc and connect it to one set of plates of the oscilloscope. Connect the terminals on top of the bridge to the other set of plates of the oscilloscope. Set the GENERATOR switch at AC INTERNAL, the DETECTOR switch at AC INTERNAL, the GENERATOR LEVEL control clockwise, the FUNCTION switch at L-DQ and the RANGE switch at 1h. Adjust the trimmer until a circle or ellipse appears on the oscilloscope. The bridge generator frequency is then equal to the frequency of the audio generator.

If an oscilloscope is not available, headphones may be used. The output of the audio generator and the bridge oscillator may be fed into the ear-phones and the trimmer adjusted until zero beat is heard. The frequency of the bridge oscillator will then equal the frequency of the audio oscillator. The bridge may still be used even if an audio oscillator is not available. Tighten the trimmer condenser by turning the screw clockwise. Then turn the screw 1/2 turn counterclockwise. This will set the oscillator at approximately 1 kc. Later adjustment may be made when additional equipment is available.

The CRL control is set as follows. Check the zero setting of the galvanometer. Set the FUNCTION switch to R. Set the GENERATOR switch to DC INTERNAL and the DETECTOR switch to DC SHUNT. Set the RANGE switch to 100 Ω on the R scale. Set the ring of the CRL control to 5. Connect the 550 Ω precision resistor supplied for calibration across the terminals on the top of the bridge. Rotate the knob of the CRL control until the galvanometer does not move when the DETECTOR switch is moved to DC METER position. The switch is spring loaded in this position so it will return to DC SHUNT position when released. Now loosen the CRL control knob and rotate it until it reads .5 on the stationary pointer. The CRL dial now will read 5.5. Tighten the CRL control knob and again check to see that the meter does not move when the DETECTOR switch is moved to DC METER position. Repeat the adjustment until the meter does not move. The CRL control is now set and ready for use.



If greater accuracy of the DQ control calibration is desired (more than that obtainable by simply zero-setting the knob), proceed in the following manner:

1. Set up the controls as outlined for the CRL calibration. Remove the 550 Ω precision resistor from the terminals on top of the bridge.
2. Disconnect the end of the wire connecting lug 2 of the rear section of the DQ control to lug 6 on the rear deck of function switch FS at the switch.
3. Temporarily connect a jumper wire (clip-leads will suffice, if available) between lug 1 of the rear section of the DQ control and lug 1 of terminal strip TS on top of the bridge. Connect another lead between lug 2 of the same rear section and lug 2 of the binding

post strip (the red post). Turn on the power. Set the CRL controls to read 160 Ω and adjust the DQ control to bring the meter to zero (this will occur near the 0.1 mark on the DQ knob). Verify this adjustment by turning the DETECTOR switch to DC METER. No pointer movement is noticeable at exact zero. The adjustment is critical, so use care.

When the bridge has been balanced, note the position of the 0.1 mark on the DQ dial with respect to the pointer. Correct the knob setting to read exactly 0.1 and rebalance the bridge to check. A double check may be made by turning the RANGE switch to 1000 Ω. The bridge should balance at 1.0 on the DQ dial.

When calibration is complete, remove the jumpers and reconnect the proper leads to the control and the switch FS.

OPERATION

CAUTION: The circuit ground and the case of this instrument are both connected to the power line ground through the green wire of the line cord. Always connect the ground test lead of this device to the chassis, or ground, of the circuit being tested or measured.

DC Resistance Measurements

1. Plug in the cord and turn on the switch mounted on the GENERATOR LEVEL control.
2. Check the zero setting of the galvanometer.
3. Connect the unknown resistance to the terminals on top of the bridge.

4. Set the FUNCTION switch to R.
5. Set the GENERATOR switch to DC INTERNAL.
6. Set the DETECTOR switch to DC SHUNT.
7. Set the CRL DIAL to zero.

For greater indicating accuracy of DC resistance measurements, external batteries may be used as follows:

Provided the CRL dial is not turned below 1, the following external battery voltages in series with additional resistance may be used:

<u>On multipliers</u>	<u>not more than</u>	<u>in series with</u>
0.1 Ω, 1.0 Ω, 10 Ω, 100 Ω..	67 1/2 V.	not less than 1500 ohms.
1 KΩ.	135 V.	not less than 4000 ohms.
10 KΩ, 100 KΩ, 1 Megohm..	202 1/2 V.	not less than 6500 ohms.

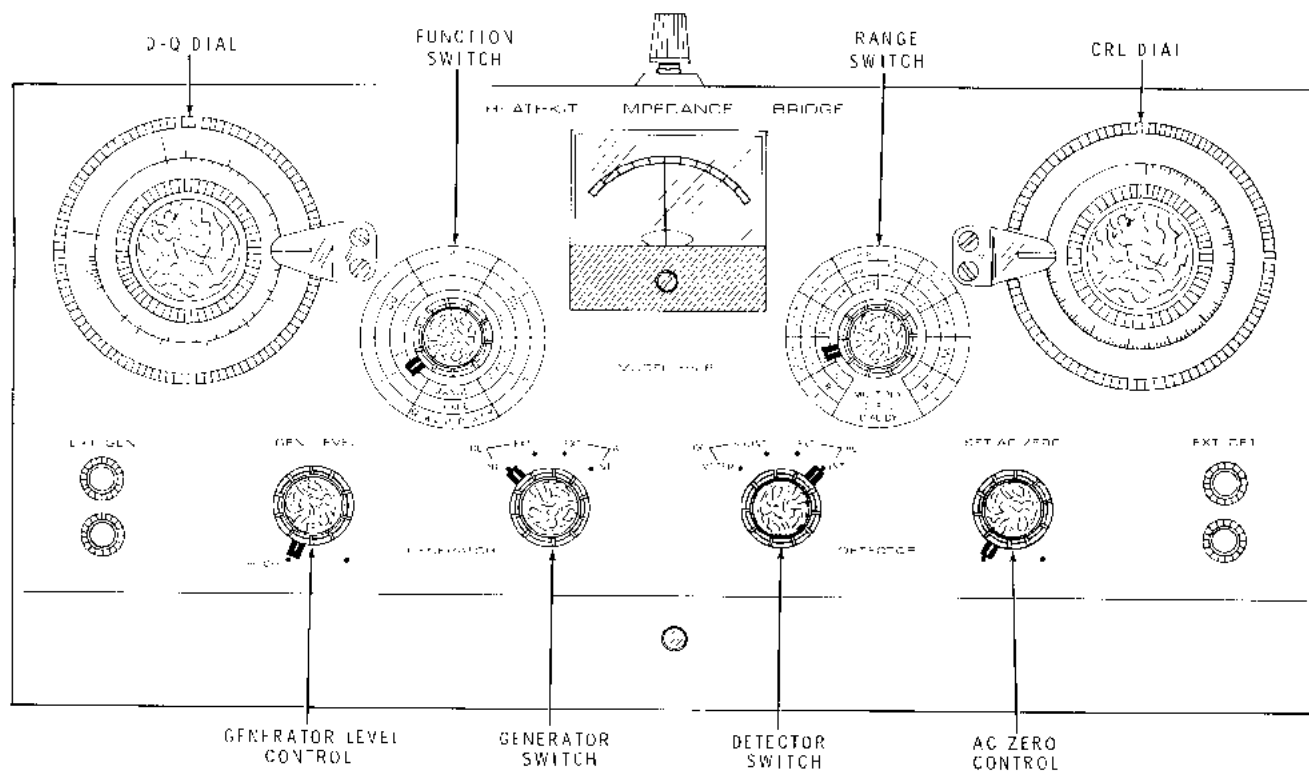

Figure 19

8. Set the RANGE switch (CRL multiplier dial) to the setting that results in minimum deflection of the galvanometer. Choose the setting that gives a reading to the left of the zero mark.
9. Turn the rim of the CRL control for approximate balance, then continue with the center knob for further balance.
10. For final balance, turn the DETECTOR switch to DC METER.
11. Multiply CRL reading by multiplier setting of the RANGE switch to find the resistance. For resistance measurements below 1 Ω , it is recommended that an external galvanometer of greater sensitivity be used.

Low resistance measurements are subject to errors due to the internal resistance of the bridge and resistances of the contacts and leads. The internal resistance of the bridge can be measured by shorting the unknown terminals with a piece of heavy wire and balancing the bridge in the usual manner. It

will probably be of the order of .02 Ω . The lead resistance can be partially eliminated by connecting the resistance directly to the binding post. Cleaning the leads also helps to minimize errors in lead resistance. When measuring low resistance, the internal resistance of the bridge should be subtracted from the measured value of resistance to give the corrected value.

Inductance Measurements at 1000 Cycles

1. Connect the unknown inductor to the terminals on top of the bridge.
2. Set the GENERATOR switch to AC INTERNAL.
3. Set the DETECTOR switch to AC INTERNAL.
4. Set the FUNCTION switch to L-DQ. Set the DQ dial at 50%.
5. Set the AC ZERO control so that the meter reads 100 microamperes counterclockwise. The GENERATOR LEVEL control should be in counterclockwise while this is done.

6. Set the GENERATOR LEVEL control so that the meter will move about half scale.
7. Set the RANGE switch so that the meter will read maximum counterclockwise.
8. Alternately adjust the CRL and DQ dials until the meter reads maximum counterclockwise. Move the GENERATOR LEVEL control clockwise as balance is approached so that at final balance it will be in maximum clockwise position. If the DQ setting tends to go above 10, set the FUNCTION switch to L-Q and again balance as above.
9. Multiply the CRL reading by the multiplier setting of the RANGE switch to find L. Q is read directly from the DQ or Q scale.

Inductance measurements at other frequencies may be made by using an external generator. Set the GENERATOR switch to EXTERNAL GENERATOR and measure as outlined for 1000 cycles.

Capacitance Measurements at 1000 Cycles

1. Connect the unknown capacitance to the terminals on top of the bridge.
2. Set the GENERATOR switch to AC INTERNAL.
3. Set the DETECTOR switch to AC INTERNAL.
4. Set the FUNCTION switch to C-DQ. Set the DQ dial to zero.
5. Set the AC ZERO control so that the meter reads 100 microamperes counterclockwise. The GENERATOR LEVEL control should be in counterclockwise position while this is done.

6. Set the GENERATOR LEVEL control so the meter will read about half scale.
7. Set the RANGE switch so that the meter will read maximum counterclockwise.
8. Adjust the CRL and DQ dials until the meter reads maximum counterclockwise. The GENERATOR LEVEL control should be moved clockwise as balance is approached so that at final balance it is in maximum clockwise position. If the DQ setting tends to go below one, set the FUNCTION switch to CD and again balance as above.
9. Multiply the CRL reading by the multiplier setting on the RANGE switch to find C. Read D directly on the DQ dial.

Capacitance measurements at frequencies other than 1000 cycles may be made by using an external generator and following the method outlined above.

The CRL reading is independent of frequency. Dissipation factor and storage factor both depend upon frequency, however, so a correction factor must be applied to the D-Q readings. For 1 kc, the D and Q readings are direct. For frequencies other than 1 kc, the dissipation factor D is obtained by multiplying the observed value of D by the frequency in kilocycles. Storage factor Q at any frequency is the observed value on the DQ dial multiplied by the frequency in kilocycles or the observed value on the Q dial divided by the frequency in kilocycles.

IN CASE OF DIFFICULTY

1. Check the wiring by following each wire on the pictorial and in the instrument, inspecting the soldered connections on each end and then checking off that wire on the pictorial with a colored pencil. This will reveal mistakes and omissions in wiring, which is the most frequent cause of difficulties. Often having a friend check the wiring will reveal a mistake consistently overlooked.
2. Check the position of the switches on the panel and be sure they are in the proper position.
3. Check the tubes.
4. Check the voltages between tube socket terminals and chassis. The readings should come reasonably close to the values tabulated below, if a vacuum tube voltmeter with 11 megohm input resistance is used. Other type meters may give considerably lower readings. If a voltage reading fails to check with the tabulation, investigate the portion of the circuit involved by checking the resistors and condensers.

Refer to the Kit Builders Guide for Service and Warranty information.

VOLTAGE CHART

SOCKET	TUBE	Pin 1	Pin 2	Pin 3	Pin 4	Pin 5	Pin 6	Pin 7
GENERATOR F	1U4	0	50-55	45-50	NC	0	.3-.35*	1.4-1.45
H	1L4	1.4-1.45	95-105	100-110	NC	1.4-1.45	NS	2.4-2.6
DETECTOR N	1U4	0	40-45	35-40	NC	0	.3-.35*	1.4-1.45
S	1L4	1.4-1.45	70-75	100-110	NC	1.4-1.45	22,23*	2.4-2.6

* - Negative with respect to chassis.
 NC - No connection.
 NS - Not significant.

All measurements made with GENERATOR LEVEL control set at maximum, GENERATOR switch at AC INTERNAL, DETECTOR switch at

AC INTERNAL, FUNCTION and RANGE switches in maximum clockwise position.

Unless otherwise indicated, all voltages are positive and measured to chassis.

Line voltage - 115 volts, 60 cycles.

BIBLIOGRAPHY

Hague, B., "Alternating-Current Bridge Methods," Sir Isaac Pitman and Sons, Ltd., London

Stout, M. B., "Basic Electrical Measurements," ch. 9, 13, Prentice-Hall, Inc., New York

Terman, F. E., "Radio Engineers' Handbook," section 13, McGraw-Hill Book Co., New York

Harris, F. K., "Electrical Measurements," ch. 7, 15, John Wiley and Sons, New York

REPLACEMENT PARTS PRICE LIST

PART No.	PRICE Each	DESCRIPTION
-------------	---------------	-------------

COMPOSITION RESISTORS

1-2	.10	68 Ω 1/2 watt
1-9	.10	1 K Ω 1/2 watt
1-44	.10	2.2 K Ω 1/2 watt
1-20	.10	10 K Ω 1/2 watt
1-22	.10	22 K Ω 1/2 watt
1-25	.10	47 K Ω 1/2 watt
1-26	.10	100 K Ω 1/2 watt
1-29	.10	220 K Ω 1/2 watt
1-33	.10	470 K Ω 1/2 watt
1-34	.10	680 K Ω 1/2 watt
1-35	.10	1 megohm 1/2 watt
1-37	.10	2.2 megohm 1/2 watt
1-71	.10	4.7 megohm 1/2 watt
1-24-1	.10	4700 Ω 1 watt
3-5-2	.10	2.2 Ω 2 watt
1-13-2	.15	220 Ω 2 watt

PRECISION RESISTORS

2-1	.70	1 Ω 1/2%
2-2	.70	9 Ω 1/2%
2-3	.70	90 Ω 1/2%
2-4	.70	100 Ω 1/2%
2-59	.70	550 Ω 1/2%
2-5	.70	900 Ω 1/2%
2-6	.60	1 K Ω 1/2%
2-7	.60	9 K Ω 1/2%
2-10	.70	90 K Ω 1/2%

CONDENSERS

31-9	.45	300-450 μ mf trimmer
20-11	.20	100 μ mf (.0001 μ fd)
21-14	.10	.001 μ fd (1000 μ mf)
23-2	.15	.005 μ fd (5000 μ mf)
20-27	1.45	.05 μ fd precision mica
23-8	.20	.02 μ fd
20-28	8.55	.1 μ fd precision mica
20-112	.25	310 μ mf 500 v mica
25-7	1.00	20-20 μ fd 150 v
25-28	.60	100 μ fd 50 v
25-26	1.75	1000-1000 μ fd 6 v

PART No.	PRICE Each	DESCRIPTION
-------------	---------------	-------------

CONTROLS-SWITCHES

10-262	.90	10 K Ω control
63-512	3.30	4-pos. detector switch
63-513	3.55	4-pos. 2 sec. gen. switch
63-514	3.50	8-pos. 2 sec. range switch
63-515	4.05	5-pos. 3 sec. function switch
13-2	5.70	165-1600-16 K Ω control
19-36	5.00	1200 Ω control w/10-pos. switch
19-127	2.45	10 K Ω control w/switch

METERS-TUBES-LAMPS

407-4	11.15	100-0-100 microampere meter
411-56	1.55	1U4 tube
411-57	1.50	1L4 tube
412-24	1.10	Pilot lamp

TRANSFORMERS-RECTIFIERS

51-16	5.05	Bridge transformer
54-56-24	3.95	Power transformer
57-27	.50	Silicon diode
57-6	1.30	Meter rectifier
57-12	1.90	Bridge rectifier

SOCKETS-TERMINAL STRIPS-KNOBS

434-15	.10	7-pin miniature socket
75-6	.40	Terminal board insulator
431-1	.10	1-lug terminal strip
431-2	.10	2-lug terminal strip
431-51	.10	2-lug terminal strip (vertical)
431-5	.10	4-lug terminal strip
455-50	.10	Knob insert
462-245	.25	Pointer knob
462-283	2.25	DQ knob
462-284	2.05	CRL knob
462-285	1.45	CRL ring
463-5	1.05	Stationary pointer

PART No.	PRICE Each	DESCRIPTION
----------	------------	-------------

HARDWARE

250-2	.05	3-48 x 5/16" machine screw
250-8	.05	#6 x 3/8" sheet metal screw
250-9	.05	6-32 x 3/8" machine screw
250-13	.05	6-32 x 1" machine screw
250-29	.05	6-32 x 3/4" RHMS
252-1	.05	3-48 nut
252-3	.05	6-32 nut
252-7	.05	Control nut
252-73	.05	Round speednut
253-9	.05	#8 washer
253-10	.05	Control nickel washer
254-1	.05	#6 lockwasher
254-6	.05	#6 external lockwasher
254-4	.05	Control lockwasher
255-15	.05	#6 x 1/2" spacer
259-1	.05	#6 solder lug
259-2	.05	#8 solder lug

SHEET METAL PARTS

200-528	2.00	Chassis
203-542	2.40	Panel
204-52	.10	CRL mounting bracket
90-417	6.20	Cabinet

WIRE

340-3	.05/ft	Roll #16 bus wire
344-59	.05/ft	Roll hookup wire
346-1	.05/ft	Length spaghetti (sleeving)
89-23	.75	Line cord

PART No.	PRICE Each	DESCRIPTION
----------	------------	-------------

MISCELLANEOUS

75-17	.10	Binding post insulators
75-30	.10	Strain relief, round cord
75-71	.10	Strain relief, flat cord
100-16-2	.10	Binding post cap, black
100-16-18	.10	Binding post cap, red
261-1	.05	Rubber foot
427-3	.10	Binding post base
432-27	.40	Line cord adapter
438-14	.55	Banana clip
481-1	.10	Condenser mounting wafer
331-6	.15	Solder
490-5	.10	Nut starter
595-995	2.00	Manual

The above prices apply only on purchases from the Heath Company where shipment is to a U.S.A. destination. Add 10% (minimum 25 cents) to the price when ordering from an authorized Service Center or Heathkit Electronic Center to cover local sales tax, postage and handling. Outside the U.S.A. parts and service are available from your local Heathkit source and will reflect additional transportation, taxes, duties and rates of exchange.

CHASSIS PHOTOGRAPH

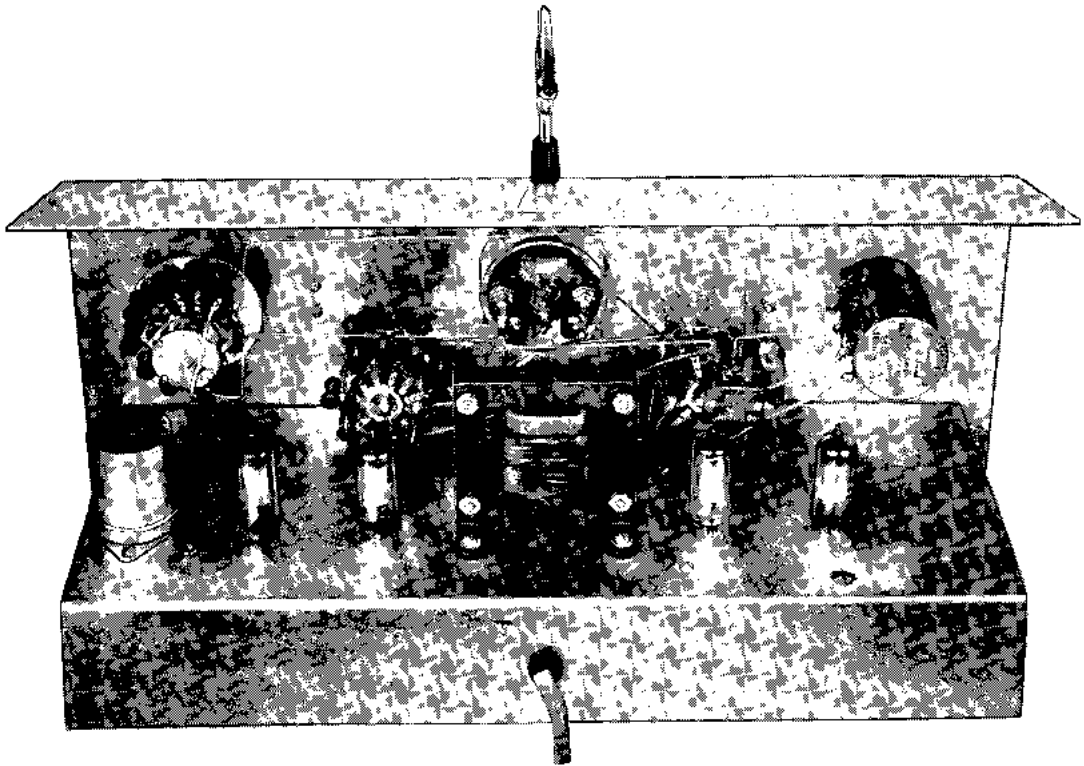

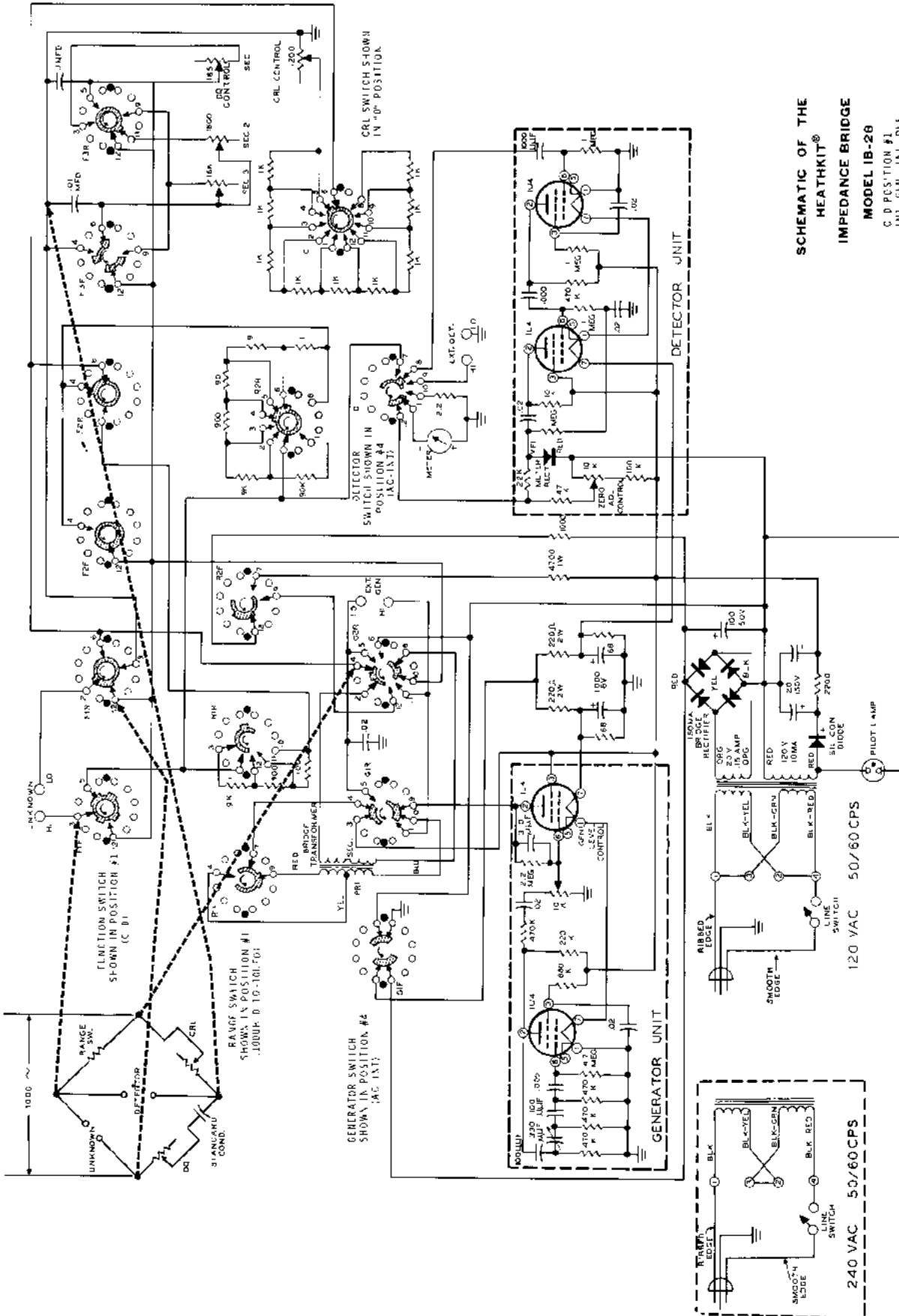

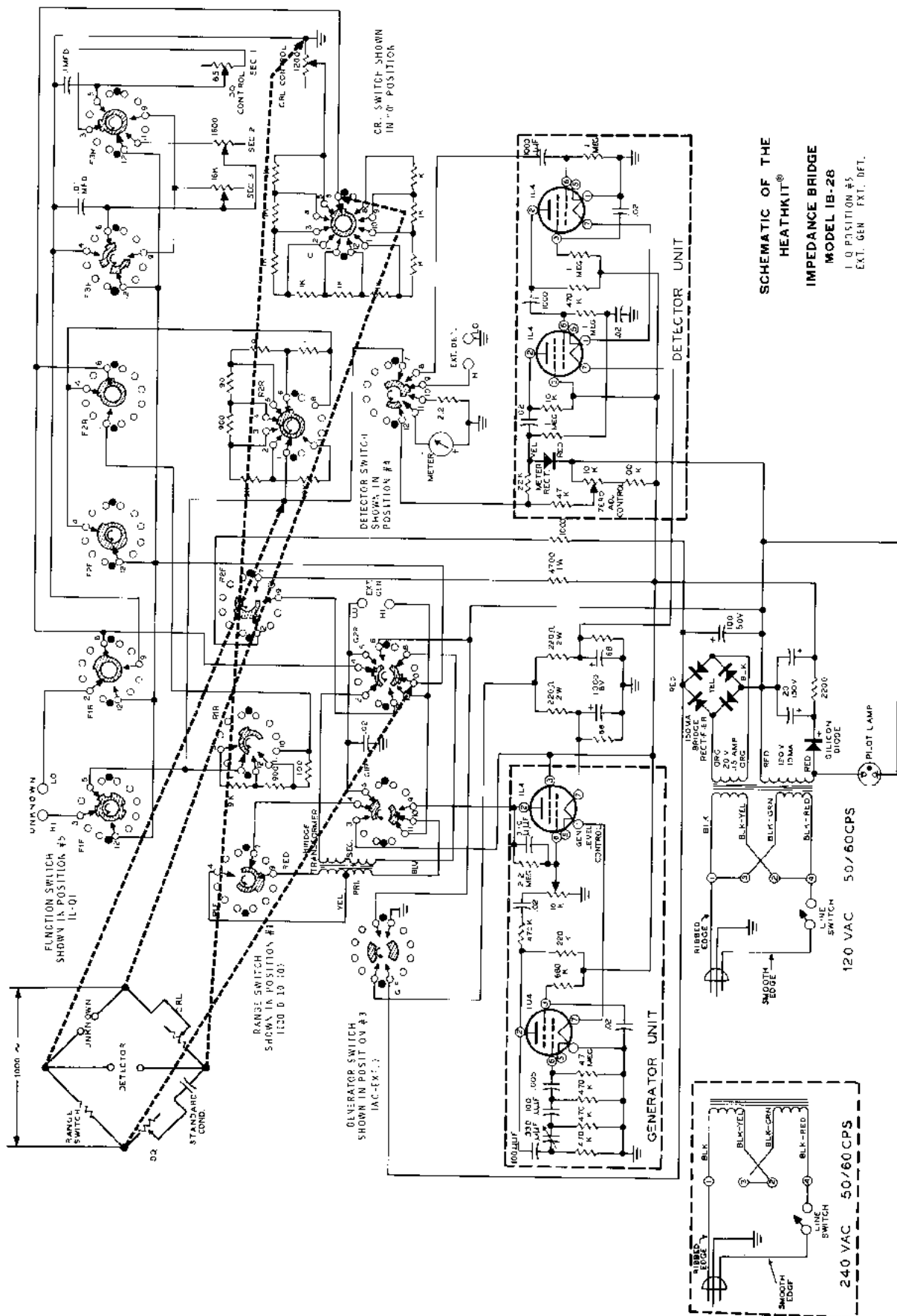

SCHEMATIC OF THE
HEATHKIT®
IMPEDANCE BRIDGE
MODEL IB-28
I. O. POSITION #5
EXT. GEN. FXT. DFT.

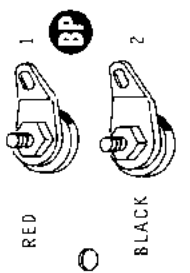
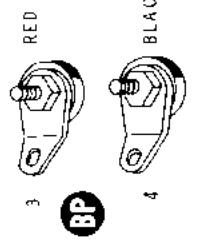
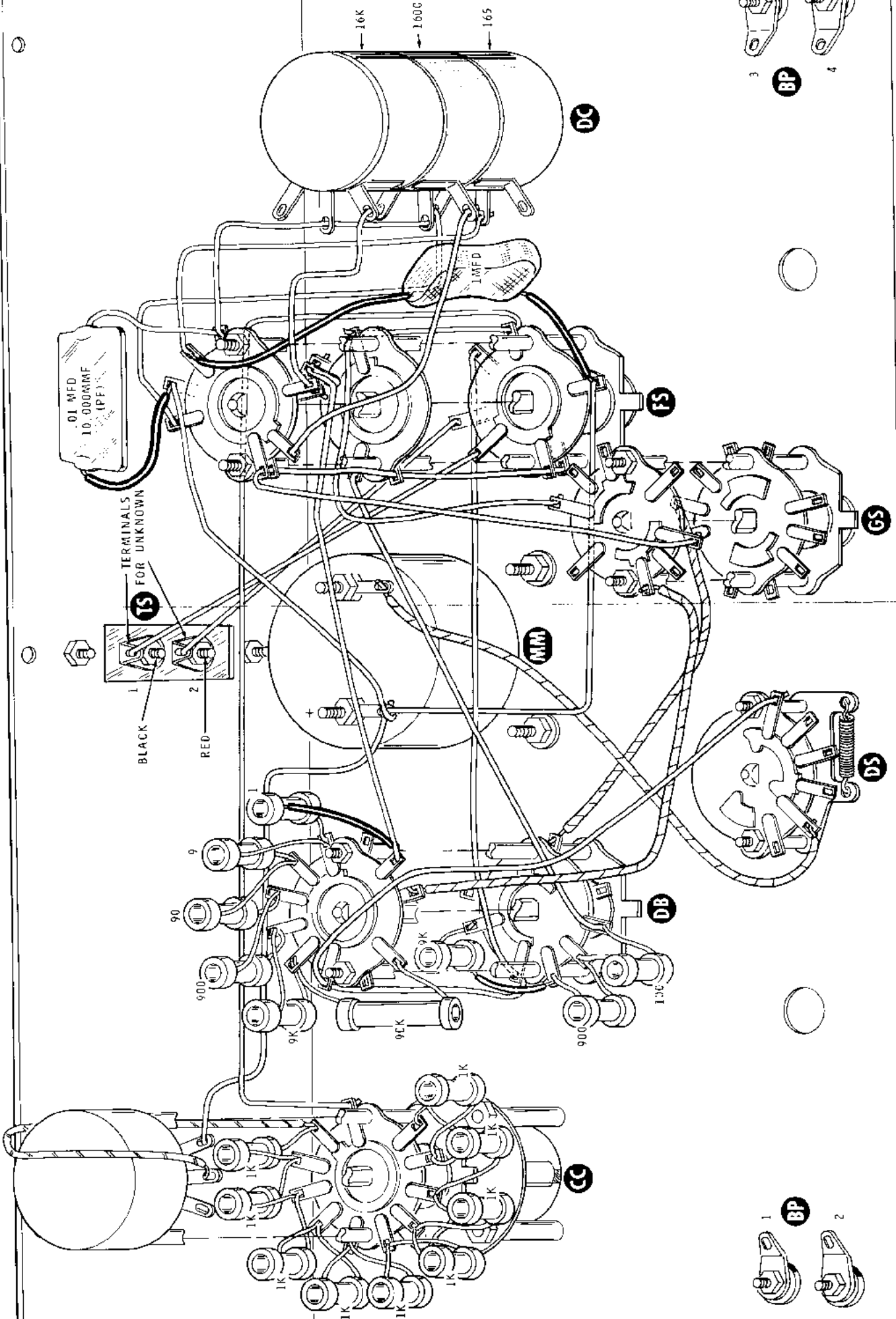

EXT.
GEN.

EXT.
DET.

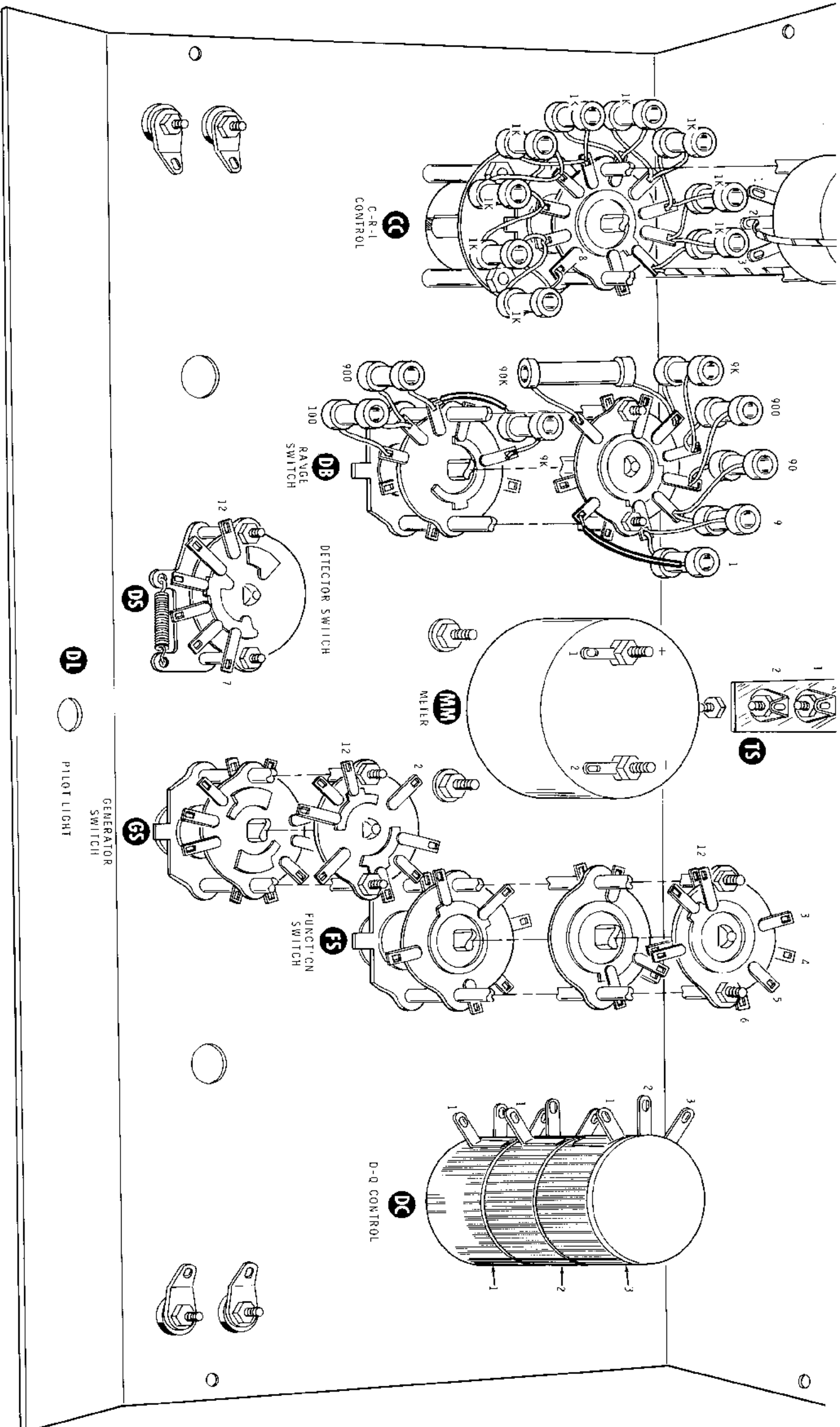

FIGURE 10

HEATH COMPANY

THE WORLD'S FINEST ELECTRONIC EQUIPMENT IN KIT FORM

LITHO IN U. S. A.

Q56 postpaid